

Freestanding French Door Refrigerator Freezer, 36", 20.1 cu ft

Series 7 | contemporary

Stainless Steel | French hinge



Designed for those who need plenty of flexible space for their cold and frozen food storage, with a stylish stainless steel finish.

- ActiveSmart™ technology helps keep food fresher for longer by constantly maintaining the ideal temperature
- Spacious bottom freezer with full extension drawer gives easy access to frozen goods

DIMENSIONS

Height	70 ¹⁵ / ₃₂ "
Width	35 ⁷ / ₁₆ "
Depth	27 ³ / ₈ "

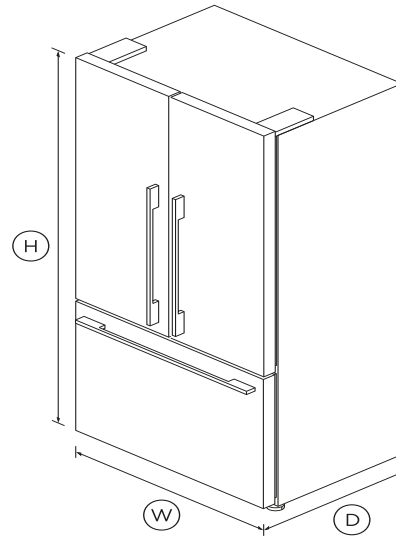

FEATURES & BENEFITS

ActiveSmart™ Foodcare

ActiveSmart™ Foodcare learns how you live. It's technology which understands how you use your fridge and adjusts temperature, airflow and humidity inside to help keep food fresher for longer.

Easy cleaning

Spill-safe secure glass shelves easily capture any drips or leaks and prevent them from falling on items below.

Design quality

Our refrigerators are designed and built using quality materials. We use real stainless steel on our refrigerators and solid glass for shelving.

Complementary Design

With their premium handle styling and stainless steel finish, our refrigerators are designed to match the rest of Fisher & Paykel's kitchen appliance family.

Humidity control

Your fruit and veges need different environments. The humidity control slides in each storage bin create a microclimate that helps keep food fresher for longer.

SPECIFICATIONS

Accessories (sold separately)

Contemporary round handle kit	Part number 25377
-------------------------------	-------------------

Capacity

Freezer	5.5cu ft
Refrigerator	14.6cu ft

Consumption

Energy usage	448kWh/year
--------------	-------------

Freezer features

Bottle chill	•
Fast freeze	•
Ice tray	1
Ice trays	1
Large plastic bin	•
Small plastic bins	1

Performance

- ActiveSmart™ Foodcare •
- ActiveSmart™ technology •
- Adaptive defrost •
- Frost free freezer •
- Humidity control system •
- Sabbath mode •

SKU 25071

The product dimensions and specifications in this page apply to the specific product and model. Under our policy of continuous improvement, these dimensions and specifications may change at any time. You should therefore check with Fisher & Paykel's Customer Care Centre to ensure this page correctly describes the model currently available. © Fisher & Paykel Appliances Ltd 2019.

Product dimensions

Depth	27 ³ / ₈ "
Height	70 ¹⁵ / ₃₂ "
Minimum air clearance - at rear	1- ³ / ₁₆ " "
Minimum air clearance - each	¹³ / ₁₆ " "
Width	35 ⁷ / ₁₆ "







Refrigerator features

Adjustable door shelves	6
Adjustable glass shelves	3
Covered door shelves	2
Deli storage bins	2
Door alarm	•
Fruit and vegetable bins	2
Full width door shelves	2
SmartTouch control panel	•
Stackable bottle holders	4

Warranty

Parts and labor	2 years
Sealed system parts only	5 years

Other product downloads available at fisherpaykel.com

-  [User Guide](#)
-  [Service & Warranty Booklet](#)
-  [Guide D'Utilisation](#)
-  [Installation Guide](#)
-  [Installation Guide \(Quick Reference\)](#)
-  [Guide D'Installation](#)
-  [Resources \(zip\)](#)



A PEACE OF MIND SALE
24 Hours 7 Days a Week Customer Support
T 1300 650 590 W www.fisherpaykel.com